

## Pre-instruction Literature

### On Receipt

It is our policy to promote safe delivery of all orders. This product shipment has been thoroughly checked, packed and quality certified before leaving our factory.

### Visible Loss or Damage

If any of the goods called for on the bill of lading or express receipt are damaged or the quantity is short, do not accept them until the freight or express delivery agent makes an appropriate notation on your freight bill or receipt.

### Concealed Loss or Damage

When a shipment has been delivered to you in apparent good condition, but upon opening the packaging if any loss or damage has taken place while in transit, inform the carrier's agent / A. O. Smith representative immediately.

### About this manual

This manual is a guide to good practice for operating and periodic maintenance of the A. O. Smith ForceNXT Water Heater. Do not operate the Water Heater before reading the user manual.

Please follow instructions in this manual to ensure personal safety and proper operation of this product. Always install, operate, inspect and maintain this product in accordance with all applicable standards. Please store this user manual carefully for any future reference.

### Disposal of this Product

(Waste Electrical and Electronic Equipment)



This marking on the product, accessories or User Manual indicates that the product and its electronic accessories (e.g. Remote, batteries and other replaceable electronic accessories) should not be disposed of with other household waste at the end of their working life. To prevent possible harm to the environment or human health from uncontrolled waste disposal, please separate these items from other types of waste and recycle them responsibly to promote the sustainable re-use of material resources.

Household users should contact their local government office, for details of where and how they can take these items for environmentally safe recycling. This product and its electronic accessories should not be mixed with other commercial wastes for disposal.

1

## General Instructions

### Safety

Your safety and the safety of your loved ones is paramount. There are several safety related messages in this manual, which have been provided during various steps such as the installation, operation and maintenance of your ForceNXT Water Heater. These messages point out potential hazards and also educate on how to reduce any potential risks. Please always read and follow all safety messages as provided in this user manual.

	This is the safety alert symbol. This symbol alerts you to potential hazards that can hurt you and others. All safety messages will follow the safety alert symbol and either the word "DANGER" or "WARNING".
	Indicates an imminently hazardous situation which, if not avoided, will result in death or serious injury.
	Indicates a potentially hazardous situation, which if not avoided, could result in death or serious injury.
	Indicates a potentially hazardous situation which, if not avoided, may result in minor or moderate injury or property damage.

### WARNING

Do not use this Water Heater if any part has been under water. Immediately contact an Authorised Service Technician to inspect the Water Heater and contact A. O. Smith Service personnel to replace any part of the control system which has been under water. Failure to follow this instruction can result in property damage, serious injury or death.

### IMPORTANT

These instructions have been written as a guide for the proper installation and operation of your Water Heater. A. O. Smith will not accept any liability where these instructions have not been followed. However, for your safety and to avoid damage caused by improper installation, it is recommended that Water Heater must be installed by an Authorised Service Technician.

Before proceeding with the installation instructions:

1. Inspect the Water Heater and its component parts for possible damage. Do not install or attempt to repair any damaged component parts. If you detect any damage in the Water Heater, please contact the dealer where the Water Heater was purchased or call A. O. Smith Customer Care Centre.
2. Verify that the voltage being supplied corresponds to that which is marked on the Water Heater manual.

2

## Specifications

Model		ForceNXT
Volume [L]		3
Power [W]		3000
Voltage/Frequency [V/Hz]		230~/50
Rated water pressure	N/cm <sup>2</sup>	65
	Water head (metres)	65
Inlet/Outlet connections [inch]		½ BSP
Net Weight (kgs.)		2.54

### Dimensions

Model	3 L	Model	3 L
A (mm)	325	D (mm)	180
B (mm)	202	E (mm)	70
C (mm)	70		

Figure 1

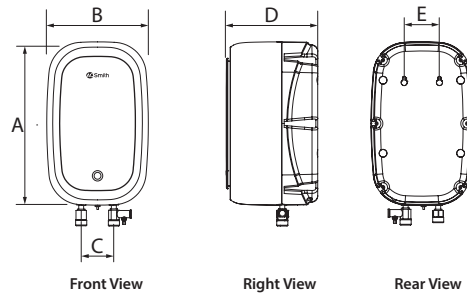

3

Figure 2

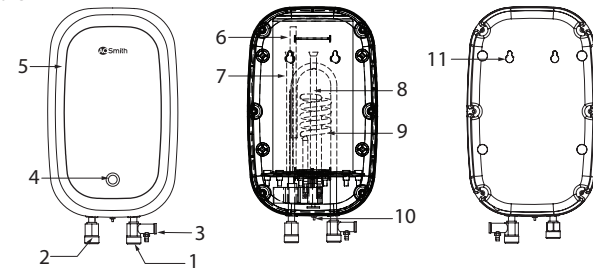

Part	Description	Part	Description
1	Cold water inlet	8	Thermostat
2	Hot water outlet	9	Heating Element
3	Pressure relief valve	10	Reset button
4	Heating indicator lamp	11	Wall mount slot
5	Front cover		
6	Outlet pipe		
7	Thermal Cut-out		

Note: Press the Reset button only when Thermal cut-out has tripped.

### WARNING

Do not tamper or detach the Pressure relief valve from the Water Heater.

4



Product colour and image may vary from the actual product.  
Part No. : 335300-092\_A Date: 01-02-2023



## FORCENXT Instant Water Heater 3 Litres

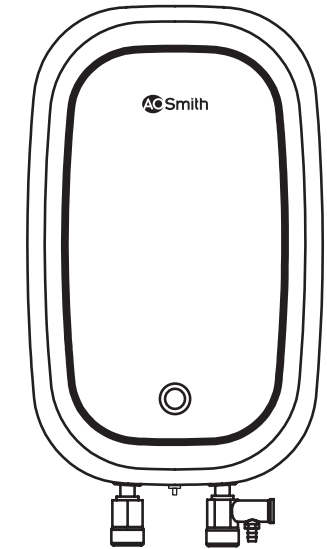

## User Manual

## Safety Precautions

### During Installation

Do not install the Water Heater where there is direct sunlight or rain. It is has to be installed indoor only.

Figure 3

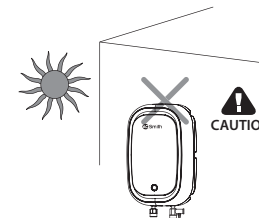

Do not install the Water Heater where water splashes on the Water Heater.

Figure 4

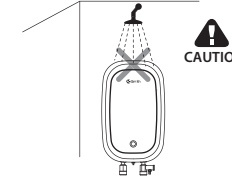

## Installation

Before installing, ensure the tools Adjustable wrench, Teflon tape, Measuring tape, Hammer, Bubble level indicator and Impact drill tool are available.

### Mounting the Water Heater

- Select a place to mount Water Heater vertically with water connection at the bottom.

Figure 5

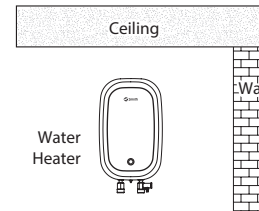

- Water Heater must be located within 2 ft. (approx.) from a 230 V electrical outlet with proper grounding.
- Make sure that the wall can withstand at least twice the weight of the Water Heater when completely filled with water.

Figure 6

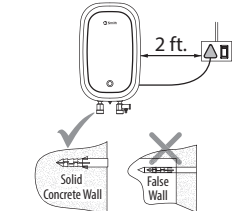

Note: Power Plug is shown only for reference.

5

Use a drill bit with diameter of 6 mm to drill 2 holes at least 32 mm deep in the wall (Step 3). The two holes should be aligned horizontally.

Figure 7

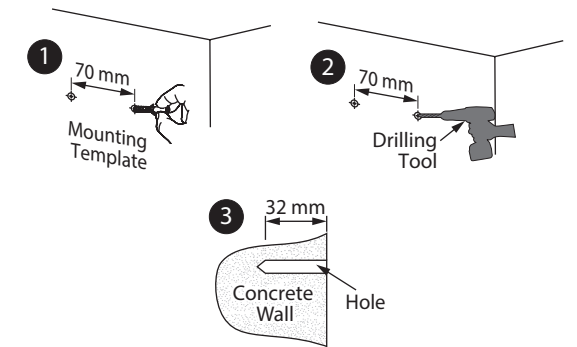

1. Insert the Expansion anchor into the hole (Step 1).
2. Insert the Mounting screw into the Expansion anchor, tighten the Mounting screw by rotating it till it gets fixed steadily and maintain minimum distance of 20 mm (between concrete wall and Mounting screw head) to mount the Water Heater (Step 2).

Figure 8

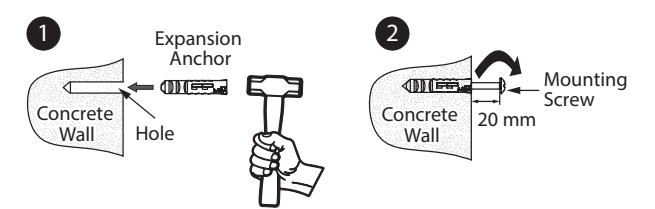

6

Mount the Water Heater on the Mounting screw through Wall mount slot. Tug downwards on the Water Heater to ensure that the Water Heater is fixed steadily.

Figure 9

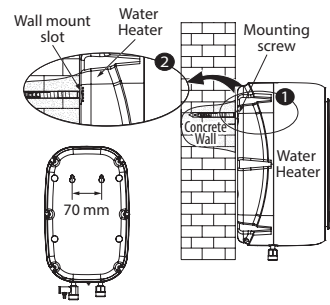

**⚠ DANGER**



Scalding

Hot water is dangerous, especially for the young children, aged or the disabled. The Water Heater allows you to control the temperature of your hot water. Water temperatures over 52°C can cause severe burns instantly or death from scalds. Do not leave a child or an infirm person in the bath unsupervised.

**Connecting to Water Supply**

Figure 10 Installation Diagram

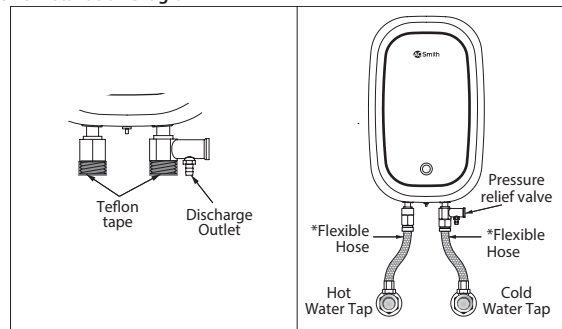

\*Flexible Hoses to be procured by the customer, not part of standard product.

1. Wrap the Teflon tape around the inlet and outlet connections of the Water Heater to prevent leakage.
2. Make necessary plumbing with reference to the Installation Diagram. (Refer "Installation Diagram")
3. Connect the cold water pipe to the inlet.
4. Connect the hot water pipe to the outlet.

**Note:**

- A. O. Smith recommends Nylon/ Stainless Steel (SS) braided hoses (Flexible Hoses) having a minimum pressure rating of 6.5 Bar and hoses should be compatible for hot water applications.
- The Pressure relief valve may drip during the usage of the heater. As the water is heated, it expands and tries to flow back through the inlet pipe but this is prevented by the presence of the non-return valve (an external valve provided before cold water tap). Hence water may drip from the Pressure relief valve. Therefore, Discharge Outlet is provided to discharge water from the Water Heater. To avoid dripping, it is recommended to install non-return valve at a distance of at least 40 feet away from the inlet of the Water Heater.

**⚠ CAUTION**

- Make sure a suitable Teflon tape is used for all plumbing connections to prevent leakage.
- Use only Nylon/ Stainless Steel (SS) braided hoses (Flexible Hoses) having a minimum pressure rating of 6.5 bar and hoses should be compatible for hot water applications.
- Failure to follow this instruction can result in property damage.

**Operation**

**Filling the Water Heater Tank**

Figure 11

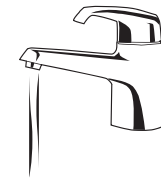

1. Open a nearby hot water faucet to permit air to escape.
2. Open the cold water inlet valve fully, filling the Water Heater and the piping.
3. Close hot water faucet when water flows.
4. Check all the connections to see if there is any leakage. In case of a leakage, drain the water completely, repair the leaking joint and then refill the Water Heater.

**⚠ CAUTION**

- This Water Heater should not be operated with insufficient amount of water. Failure to do so may result in damage to the Water Heater and injuries to the user. This will also make the warranty null and void.
- Once the Mounting, Plumbing and Water filling is completed, then only the power supply should be switched ON.
- Do not splash water directly or clean with benzene, pesticides, thinner, alcohol, etc., but use a soft, dry cloth to clean the Water Heater.

**Connecting to Electrical Supply**

Figure 12

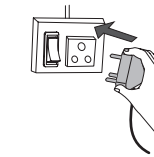

- Customer should procure a suitable plug with adequate ratings for 3 kW unit.
- For a 3 kW unit, the power plug should be having a minimum 16 Amps rating.
- Find a separate socket for power plug and make sure the socket is in firm contact with the plug. Ensure that reliable earthing has been done.

**Preferred Usage pattern:** Before switching ON the power supply to the Water Heater, adjust the hot water tap to the minimum flow. Then, switch ON the power supply to the Water Heater. After 40 seconds (approx.) hot water flows continuously at a constant flow.

**⚠ CAUTION**

- Connect the Water Heater using independent sockets, do not use any adapters. Use multimeter to check whether the live line and neutral line are not reverse, to ensure complete safety.
- Before installing the Water Heater, confirm that the power of Water Heater matches electric meter capacity and supply wire.
- The Water Heater should be earthed reliably. It is prohibited to connect the earth wire to neutral wire or faucet water pipe.
- If the power supply cord is damaged, it must be replaced by the manufacturer or Authorised Service Technician in order to avoid a hazard.

**Connecting power cord and plug**

- The RED, BLACK and GREEN wires in the power cord corresponds to Live, Neutral and Earth connections.
- These should be connected in the plug accordingly. It is not permitted to leave out or short the earth wire with Neutral.
- Reliable earthing in the circuit should be ensured by the customer before installation.
- Ensure that the Live, Neutral and Earth Terminals in the plug corresponds to the same in the socket.

- Use a pen multimeter to check the socket for any reversed Live and neutral lines and take corrective action by a qualified electrician if required.
- This Water Heater comes with factory pre-set temperature. Switch on the Water Heater's power supply. The Heating indicator lamp glows.

Figure 13

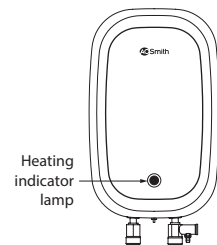

**Modes**

There are two types of modes depending on the actual water temperature inside the inner tank of the Water Heater:

Heating mode	Standby mode
When the actual temperature of the water is less than the factory pre-set temperature, it enters into Heating mode. The Heating indicator lamp glows in blue color as shown in "Figure 14".	After the Water Heater reaches factory pre-set temperature, it will enter into the Standby mode due to the thermostat cut-off and Heating indicator lamp glows in orange color as shown in "Figure 15".

When the temperature of the water drops by 5°C from the factory pre-set temperature due to usage of water, the Water Heater again enters into the Heating mode.

**Troubleshooting**

The Water Heater may not operate as desired if used incorrectly or there is a minor cause, even though the product has no fault. In these cases, check the following issues to solve simple problems without the help from the Customer Care Centre. If the problem does not solve after checking the following issues, call Customer Care Centre.

Problems	Possible Cause(s)	Solution
Heating indicator lamp does not glow and no hot water.	No power supply to the Water Heater.	Check power supply and switch ON electrical switch.
	Thermal Cut-out has tripped or problem in internal wiring.	Press the Reset button and switch ON electrical switch, if problem persists call Customer Care Centre.
Heating indicator lamp glow but no hot water.	Heating Element breakdown or internal wiring error.	Call Customer Care Centre.
Water temperature is too high.	Improper thermostat operation.	Call Customer Care Centre.
	Thermal Cut-out not operating.	Call Customer Care Centre.
Water heats slowly.	Low voltage at supply mains.	Check voltage at supply mains.
	Scale deposition.	Call Customer Care Centre.
Piping connection leaks.	Connection not sealed.	Re-connect piping, using Teflon tape.
Water leakage from product.	Leakage in tank or other parts.	Switch OFF power immediately and call Customer Care Centre.
Water dripping from Pressure relief valve during heating.	Non-return valve is installed close to the inlet of the Water Heater.	Install Non-return valve at a distance of at least 40 feet from the inlet of the Water Heater (Refer page 9), if problem still persists call Customer Care Centre.

Problems	Possible Cause(s)	Solution
Foul smell from hot water.	Presence of organic matter in input water.	Provide treated water at the input.
	No usage of hot water for a long time period	If the Water Heater is not used for an extended period of time, drain the water from the Water Heater. Ensure water is filled back before use of Water Heater.
	High electrical conductivity of water due to dissolved solids in input water.	Call Customer Care Centre. Anode options available for highly conductive water.

**Note:** Call Customer Care No. 1800-103-2468/1860-500-2468.

**Circuit Diagram**

Figure 16

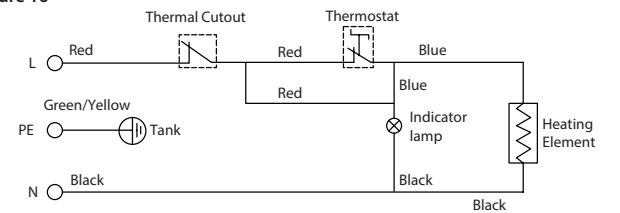

**⚠ CAUTION**

In order to avoid a hazard due to inadvertent re-setting of the Thermal cut-out, this Water Heater must not be supplied through an external switching device, such as a timer, or connected to a circuit that is regularly switched ON and OFF by the utility.